





120×120×25 mm

San Ace 120 9GA type Low Power Consumption Fan   

General Specifications

- Material Frame: Plastic (Flammability: UL 94V-0), Impeller: Plastic (Flammability: UL 94V-0)
- Expected life See the table below. (L10 life: 90% survival rate for continuous operation in free air at 60°C, rated voltage)
- Motor protection function Locked rotor burnout protection, Reverse polarity protection
For details, please refer to p. 529.
- Dielectric strength 50/60 Hz, 500 VAC, for 1 minute (between lead wire conductors and frame)
- Insulation resistance 10 MΩ or more with a 500 VDC megger (between lead wire conductors and frame)
- Sound pressure level (SPL) At 1 m away from the air inlet
- Storage temperature -30 to +70°C (Non-condensing)
- Lead wire ⊕Red ⊖Black (Sensor) Yellow (Control) Brown
(For models without PWM control function, there is no speed control wiring.)
- Mass 280 g

Specifications

The models listed below **have ribs and pulse sensors with PWM control function**. For models without ribs, append "1" to the end of model numbers.

Model no.	Rated voltage [V]	Operating voltage range [V]	PWM duty cycle* [%]	Rated current [A]	Rated input [W]	Rated speed [min ⁻¹]	Max. airflow [m ³ /min] [CFM]	Max. static pressure [Pa] [inchH ₂ O]	SPL [dB (A)]	Operating temperature [°C]	Expected life [h]
9GA1212P4G001	12	10.2 to 13.8	100	0.93	11.16	6400	3.8 134	365 1.47	57	-20 to +70	40000/60°C (70000/40°C)
			25	0.16	1.92	2550	1.5 53	60 0.24	34		
9GA1212P4S001			100	0.61	7.32	5400	3.2 113	260 1.04	54		
			25	0.16	1.92	2550	1.5 53	60 0.24	34		
9GA1224P4G001	24	20.4 to 27.6	100	0.47	11.28	6400	3.8 134	365 1.47	57		
			25	0.1	2.4	2550	1.5 53	60 0.24	34		
9GA1224P4S001			100	0.31	7.44	5400	3.2 113	260 1.04	54		
			25	0.1	2.4	2550	1.5 53	60 0.24	34		
9GA1248P4G001	48	40.8 to 53	100	0.24	11.52	6400	3.8 134	365 1.47	57		
			25	0.08	3.84	2550	1.5 53	60 0.24	34		
9GA1248P4S001			100	0.16	7.68	5400	3.2 113	260 1.04	54		
			25	0.08	3.84	2550	1.5 53	60 0.24	34		

* PWM frequency: 25 kHz. Fan does not rotate when PWM duty cycle is 0%.

The models listed below **have ribs and pulse sensors**. For models without ribs, append "1" to the end of model numbers.

Model no.	Rated voltage [V]	Operating voltage range [V]	Rated current [A]	Rated input [W]	Rated speed [min ⁻¹]	Max. airflow [m ³ /min] [CFM]	Max. static pressure [Pa] [inchH ₂ O]	SPL [dB (A)]	Operating temperature [°C]	Expected life [h]
9GA1212G4001	12	7 to 13.8	0.93	11.16	6400	3.8 134	365 1.47	57	-20 to +70	40000/60°C (70000/40°C)
9GA1212S4001			0.61	7.32	5400	3.2 113	260 1.04	54		
9GA1224G4001	24	14 to 27.6	0.47	11.28	6400	3.8 134	365 1.47	57		
9GA1224S4001			0.31	7.44	5400	3.2 113	260 1.04	54		
9GA1248G4001	48	36 to 53	0.24	11.52	6400	3.8 134	365 1.47	57		
9GA1248S4001			0.16	7.68	5400	3.2 113	260 1.04	54		

Other sensor specifications are available as options. Refer to the index (p. 553).

Airflow - Static Pressure Characteristics / PWM Duty - Speed Characteristics Example

9GA1212P4G001 With pulse sensor with PWM control function

PWM duty cycle

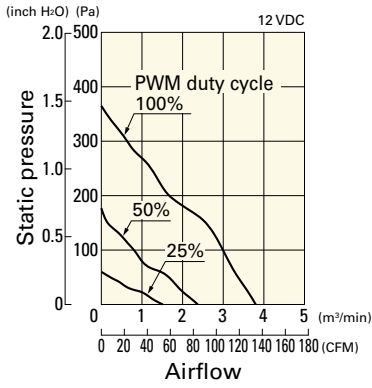

Operating voltage range

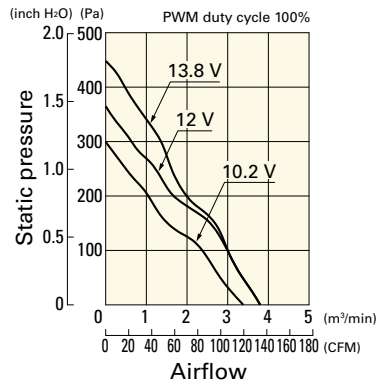

PWM duty - Speed characteristics example

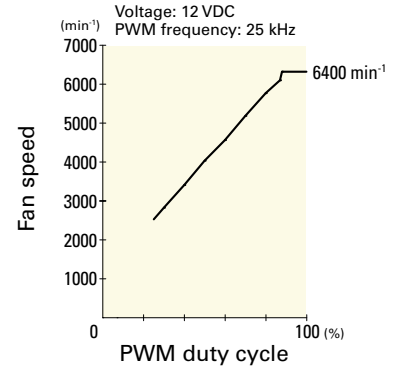

9GA1212P4S001 With pulse sensor with PWM control function

PWM duty cycle

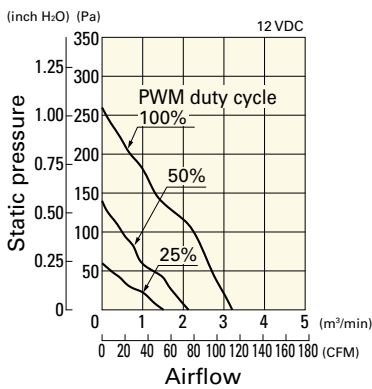

Operating voltage range

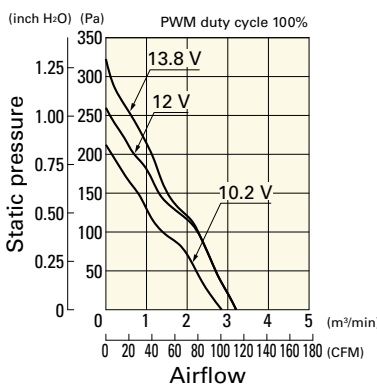

PWM duty - Speed characteristics example

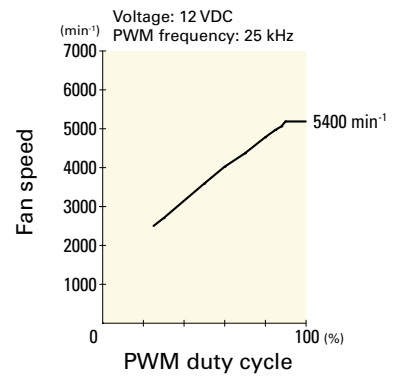

9GA1224P4G001 With pulse sensor with PWM control function

PWM duty cycle

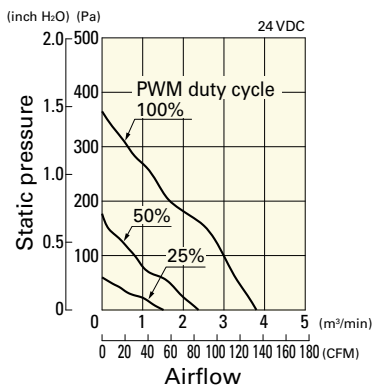

Operating voltage range

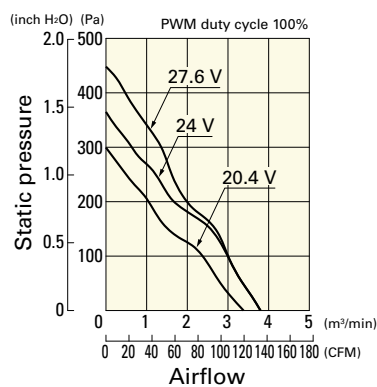

PWM duty - Speed characteristics example

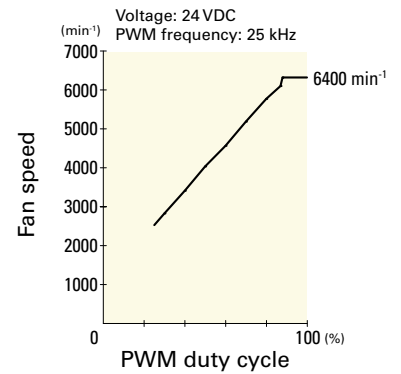

9GA1224P4S001 With pulse sensor with PWM control function

PWM duty cycle

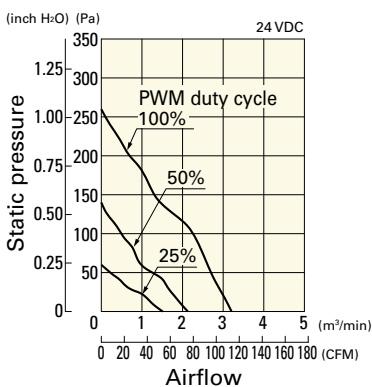

Operating voltage range

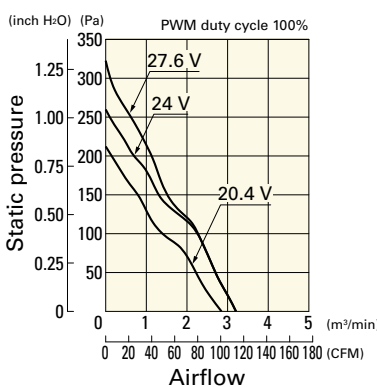

PWM duty - Speed characteristics example

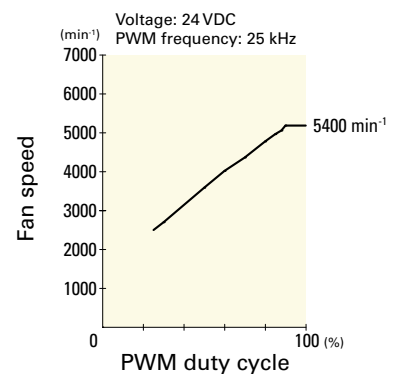

Airflow - Static Pressure Characteristics / PWM Duty - Speed Characteristics Example

DC

DC Fan 120 mm sq.

9GA1248P4G001 With pulse sensor with PWM control function

PWM duty cycle

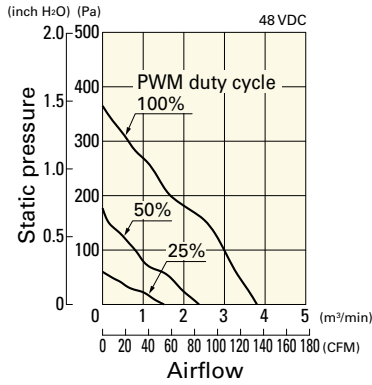

Operating voltage range

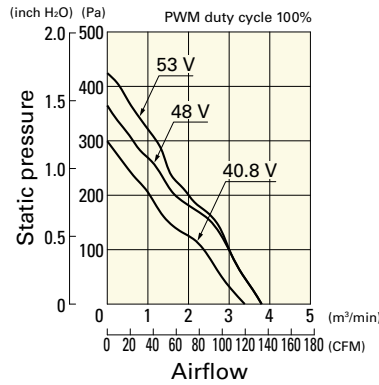

PWM duty - Speed characteristics example

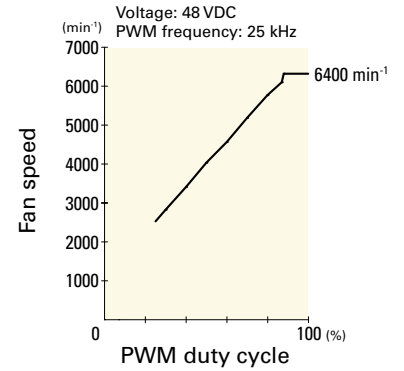

9GA1248P4S001 With pulse sensor with PWM control function

PWM duty cycle

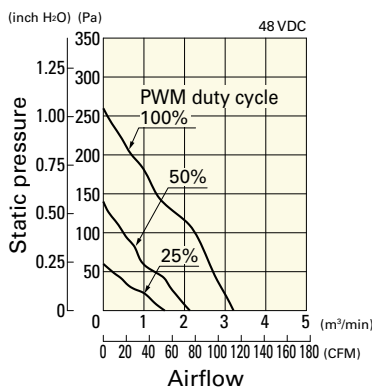

Operating voltage range

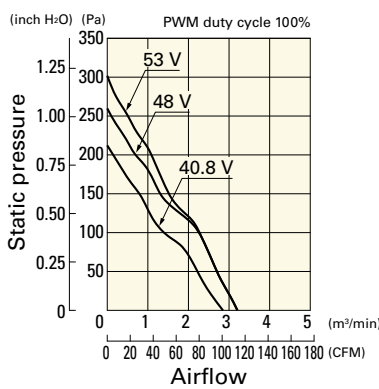

PWM duty - Speed characteristics example

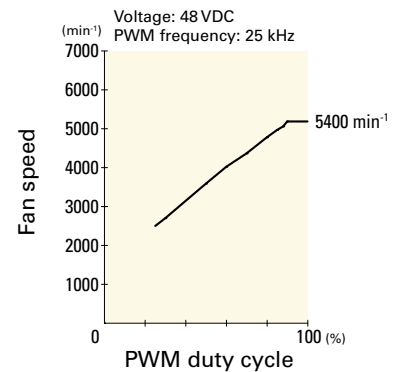

9GA1212G4001 With pulse sensor

Operating voltage range

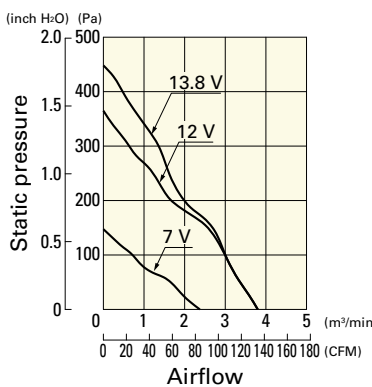

9GA1212S4001 With pulse sensor

Operating voltage range

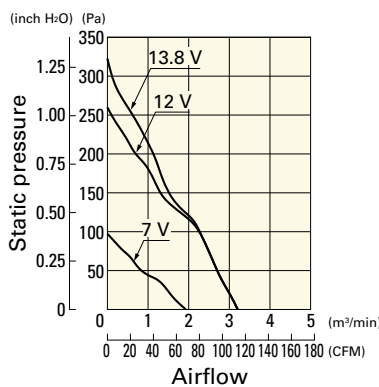

9GA1224G4001 With pulse sensor

Operating voltage range

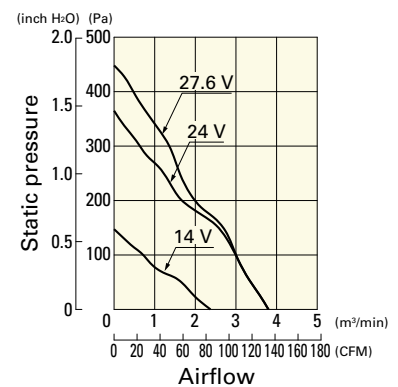

9GA1224S4001 With pulse sensor

Operating voltage range

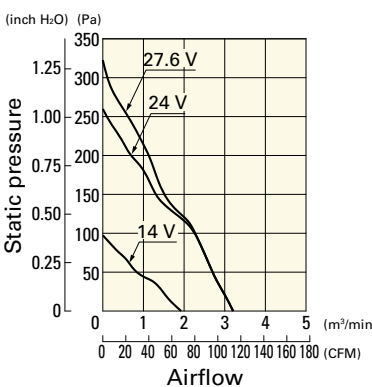

9GA1248G4001 With pulse sensor

Operating voltage range

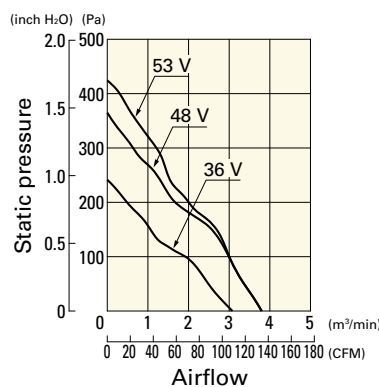

9GA1248S4001 With pulse sensor

Operating voltage range

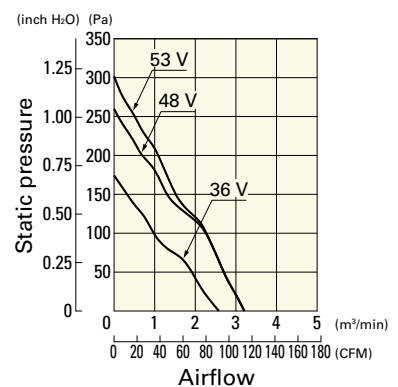

Dimensions (unit: mm) (With pulse sensor with PWM control function)

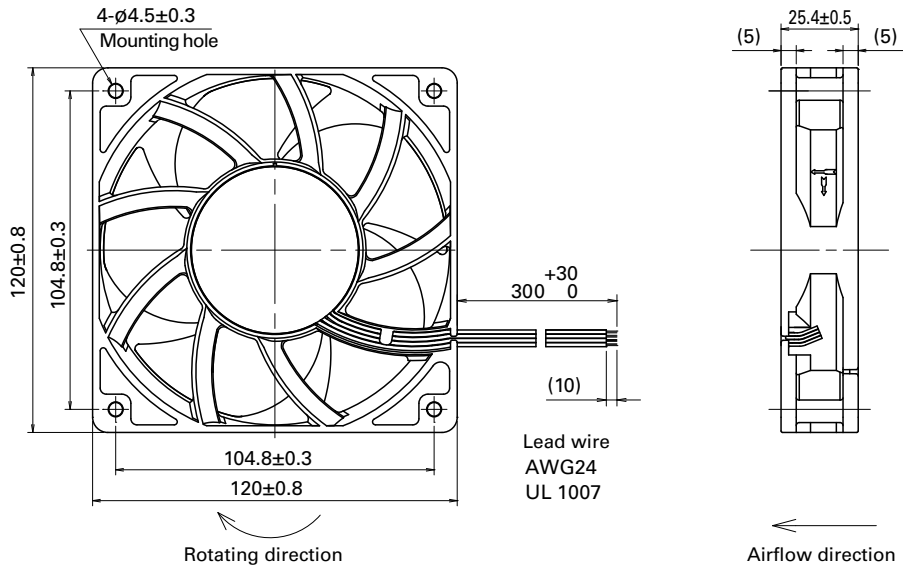

Reference Dimensions of Mounting Holes and Vent Opening (unit: mm)

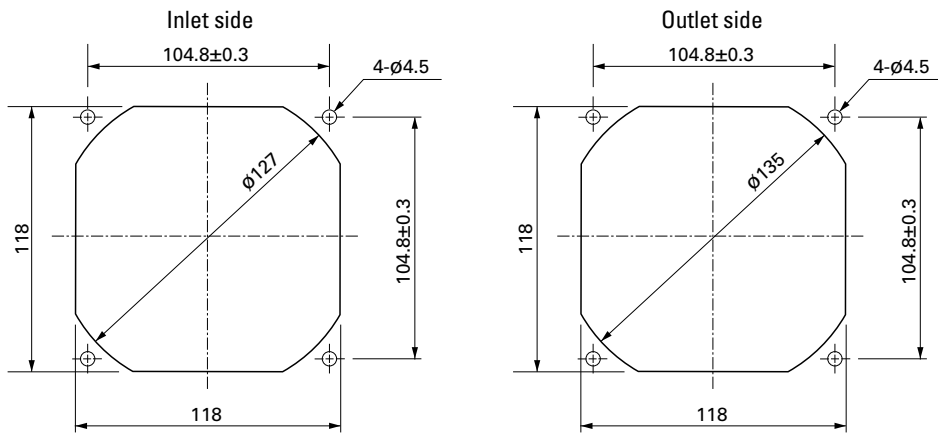

Options

Finger guards page: p. 514

Model no.: 109-019C, 109-019H, 109-019E, 109-019K

Resin finger guards page: p. 520

Model no.: 109-1000G

Resin filter kits page: p. 521

Model no.: 109-1000F13 (13PPI), 109-1000F20 (20PPI),
109-1000F30 (30PPI), 109-1000F40 (40PPI)